

TECHNICAL DATA

Power supply	1 9V 500mA alkaline battery
Current drained in resting conditions	33 μ A
Current drained when transmitting	6 mA
Operation with alkali battery	ca 1 year
Alarm detection	Fresnel lens and double pyroelectric sensor
Area covered	10 m
Horizontal opening	90 degrees
Vertical opening	75 degrees on three protection levels
Protection beams	14 (on three levels)
Minimum range of transmitter in free air	20 m
-10 / +50°C	Operating temperature
433.92 MHz	Transmission frequency

This device is warranted against all construction or operating defects for a period of 12 months of the date of manufacture given on the warranty label on the back. If this label is missing the warranty loses its validity. The manufacturer assumes no responsibility for anomalies or failures to the alarm device caused by transport or extraneous causes such as electric discharge, overvoltage, mechanical impact, flooding, or due to improper installation or non compliance with the technical data specified. The alarm has only dissuasive functions against theft.

**TECHNICAL DATA**

Power supply	1 9V 500mA alkaline battery
Current drained in resting conditions	33 μ A
Current drained when transmitting	6 mA
Operation with alkali battery	ca 1 year
Alarm detection	Fresnel lens and double pyroelectric sensor
Area covered	10 m
Horizontal opening	90 degrees
Vertical opening	75 degrees on three protection levels
Protection beams	14 (on three levels)
Minimum range of transmitter in free air	20 m
-10 / +50°C	Operating temperature
433.92 MHz	Transmission frequency

This device is warranted against all construction or operating defects for a period of 12 months of the date of manufacture given on the warranty label on the back. If this label is missing the warranty loses its validity. The manufacturer assumes no responsibility for anomalies or failures to the alarm device caused by transport or extraneous causes such as electric discharge, overvoltage, mechanical impact, flooding, or due to improper installation or non compliance with the technical data specified. The alarm has only dissuasive functions against theft.



The sensor 5000IR is an intrusion detector with passive infrareds with Fresnel lens with volumetric covering. Positioned in a corner it protects a 10 x 10 meters room.

Positioning

Determine the zone to be protected and sensor protection range keeping in mind that infrared detectors are more sensitive to transverse as opposed to frontal movements. Avoid the main causes of false alarms, which are:

- Heat sources in the proximity of the sensor
- Strong drafts reaching the sensor
- Vibrations of the supporting surface
- Unstable objects in the area to be protected
- Animals

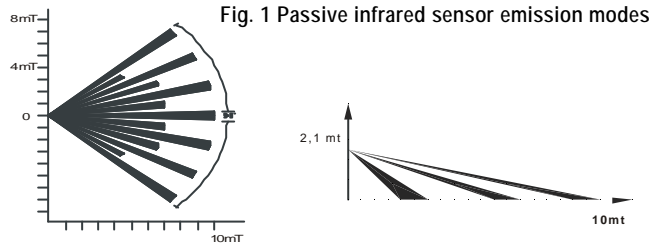

Fig. 1 Passive infrared sensor emission modes

The sensor 5000IR is an intrusion detector with passive infrareds with Fresnel lens with volumetric covering. Positioned in a corner it protects a 10 x 10 meters room.

Positioning

Determine the zone to be protected and sensor protection range keeping in mind that infrared detectors are more sensitive to transverse as opposed to frontal movements. Avoid the main causes of false alarms, which are:

- Heat sources in the proximity of the sensor
- Strong drafts reaching the sensor
- Vibrations of the supporting surface
- Unstable objects in the area to be protected
- Animals

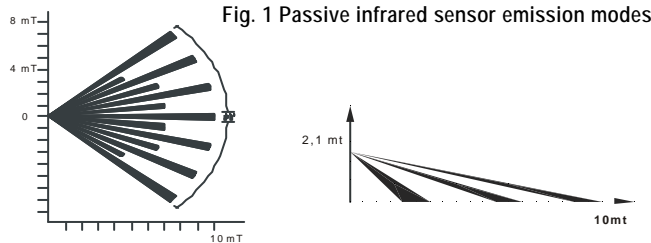

Fig. 1 Passive infrared sensor emission modes

Operation

As soon as it detects an intrusion, sensor 5000IR transmits a radio signal to the control unit. When the alarm cause has been removed, the 5000IR is inhibited automatically for ca 3 minutes, then it becomes ready to detect the next alarm. If the cause of the alarm persists, the inhibition period is continuously renewed. NOTE: During the sensor inhibition time, the sensor anti-tampering function is always active.

Low battery signal

When battery voltage drops below 6 V, the sensor indicates this condition by giving out an audible signal lasting ca 1 second. This indication is given out every 3 hours and each time the sensor detects a movement.

Battery replacement

1. Access the programming function (see paragraph 3.1 in the installation manual). In these conditions, in fact, the control unit does not detect the sabotage alarm caused by the opening of the sensor.
2. Open the sensor
3. Replace the battery
4. Close the sensor
5. Quit the programming function.

Operation

As soon as it detects an intrusion, sensor 5000IR transmits a radio signal to the control unit. When the alarm cause has been removed, the 5000IR is inhibited automatically for ca 3 minutes, then it becomes ready to detect the next alarm. If the cause of the alarm persists, the inhibition period is continuously renewed. NOTE: During the sensor inhibition time, the sensor anti-tampering function is always active.

Low battery signal





When battery voltage drops below 6 V, the sensor indicates this condition by giving out an audible signal lasting ca 1 second. This indication is given out every 3 hours and each time the sensor detects a movement.

Battery replacement

1. Access the programming function (see paragraph 3.1 in the installation manual). In these conditions, in fact, the control unit does not detect the sabotage alarm caused by the opening of the sensor.
2. Open the sensor
3. Replace the battery
4. Close the sensor
5. Quit the programming function.

Infrared ray sensor operating test

The 5000IR is equipped with two jumpers: J1 (walk test) and J2 (RF test).





<p>J1 ON Walk test  WALK TEST</p>	With the jumper fitted to J1, the Walk Test mode is active. LED DL1 shows that the detection process has occurred and hence the sensor transmits an alarm signal and simultaneously LED DL2 gives out 3 flashes.
<p>J2 ON  </p>	With the jumper fitted to J2, the Test mode is active. A continuous alarm simulation will take place enabling you to determine whether the RF signal is received by the DOMUS 5000 control unit.
<p>J1 e J2 OFF  J2 </p>	With both jumpers OFF, the unit is in normal operating mode. The two LEDs, DL1 and DL2, are deactivated. In alarm conditions, the sensor will transmit a signal to the DOMUS 500 control unit without causing the lighting of the LEDs.

Sensitivity adjustment

The 5000IR is supplied pre-set in the factory to ensure a coverage of 10 m. By means of the adjustment trimmer located inside the sensor, it is possible to change the setting and adapt the detector to the size of the room to be protected.

Infrared ray sensor operating test

The 5000IR is equipped with two jumpers: J1 (walk test) and J2 (RF test).

<p>J1 ON Walk test  WALK TEST</p>	With the jumper fitted to J1, the Walk Test mode is active. LED DL1 shows that the detection process has occurred and hence the sensor transmits an alarm signal and simultaneously LED DL2 gives out 3 flashes.
<p>J2 ON  </p>	With the jumper fitted to J2, the Test mode is active. A continuous alarm simulation will take place enabling you to determine whether the RF signal is received by the DOMUS 5000 control unit.
<p>J1 e J2 OFF  J2 </p>	With both jumpers OFF, the unit is in normal operating mode. The two LEDs, DL1 and DL2, are deactivated. In alarm conditions, the sensor will transmit a signal to the DOMUS 500 control unit without causing the lighting of the LEDs.

Sensitivity adjustment

The 5000IR is supplied pre-set in the factory to ensure a coverage of 10 m. By means of the adjustment trimmer located inside the sensor, it is possible to change the setting and adapt the detector to the size of the room to be protected.

Programming

To link up the sensor to the control unit, remove the cover and select the 8 dip switches located to the left of the printed circuit.

CAUTION: each wireless peripheral must have a unique code, different from those of all the other peripherals (see table at the end of the User Manual for possible double codes).

Access the control unit programming function by following the instructions provided in the installation manual (par. 3.1) and go to the “**PROGRAM SENSORS?**” menu (par. 3.4). Assign a code to the sensor by applying pressure to the spring of the anti-tampering button.

Assembly process

- Determine the fastening point at a distance from the floor of ca 2.1 m.
- Fasten bracket (A) to the wall.
- Align part (B) with the 4 holes in the bottom of the sensor and push in all the way, then fasten the screw supplied as standard to the inside of the spherical component of part (B).
- Introduce the spherical component of part (B) into its housing in bracket (A). Choose the desired inclination and fasten the two lateral screws.

Programming

To link up the sensor to the control unit, remove the cover and select the 8 dip switches located to the left of the printed circuit.

CAUTION: each wireless peripheral must have a unique code, different from those of all the other peripherals (see table at the end of the User Manual for possible double codes).

Access the control unit programming function by following the instructions provided in the installation manual (par. 3.1) and go to the “**PROGRAM SENSORS?**” menu (par. 3.4). Assign a code to the sensor by applying pressure to the spring of the anti-tampering button.

Assembly process

- Determine the fastening point at a distance from the floor of ca 2.1 m.
- Fasten bracket (A) to the wall.
- Align part (B) with the 4 holes in the bottom of the sensor and push in all the way, then fasten the screw supplied as standard to the inside of the spherical component of part (B).
- Introduce the spherical component of part (B) into its housing in bracket (A). Choose the desired inclination and fasten the two lateral screws.

Fig. 2

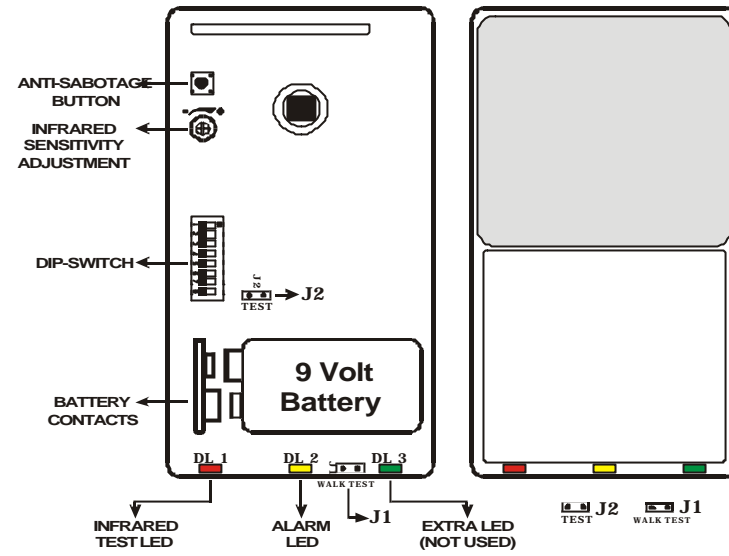
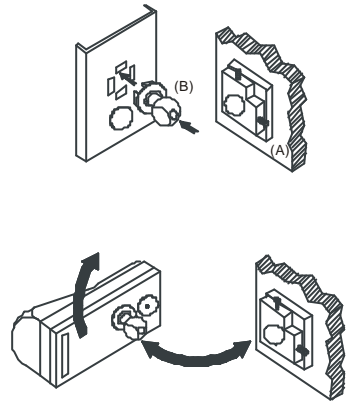

Fig. 2

